

**PRECAUTIONS** Clean the pool walls thoroughly. Rusted and/or rough metal walls may require foam padding to prevent damage to the vinyl liner. Polymer walls rarely require foam padding. Cover all panel joints and the bottom edge of the coping with fabric-based duct tape or painter's grade masking tape. Be sure to check all coping joints for sharp corners. Soften or cover any sharp projections with an appropriate material to prevent tearing of the vinyl liner during installation.

### ***The pool bottom must be prepared***

Take particular care in cleaning and smoothing the pool bottom. Inspect the pool bottom for any debris, protrusions or sharp objects and remove them before installing the vinyl liner. The customer's perception of an installer's workmanship will be largely dependent on how the bottom looks and feels.

Once the interior of the pool is properly prepared, the skimmer and return gaskets may be applied. If the pool has a main drain(s), a base gasket should be seated and fastened to each drain before the vinyl liner is installed.

Vinyl liners should be installed when the ambient temperature is 60° Fahrenheit or greater. Accommodations can be made to install a vinyl liner in cold weather by

enclosing the pool with a temporary, heated structure, though only experienced installers should attempt such a procedure. The vinyl liner should be stored in a heated space for two or more days prior to installation in cold weather.

### ***Make sure the liner is correct first!***

Check the vinyl liner box label and compare the dimensions on the graphic with those of the pool. If they match, detach the banding from the box and remove the lid. A large envelope with all the warnings, warranty and pool care information will be in the box.

**READ THE INSTRUCTIONS TO THE INSTALLER ON THE FACE OF THE ENVELOPE!** If the homeowner is present, ask him/her to look at the liner to be certain it is the pattern/color that was requested. **REVIEW THE ENVELOPE'S INSTRUCTIONS AND CONTENTS WITH THE HOMEOWNER BEFORE LEAVING THE SITE!** If the homeowner is not available, return to the site when he/she is there to review the information.

*It is legally essential that installers present the warnings and care packet to all pool owners and instruct them on the use and importance of its contents.*

### ***Positioning the liner***

Installing a vinyl liner is easiest to accomplish when done by two or more people. Once it is determined that the vinyl liner is as ordered, notice the red arrow on the top of the folded liner. Carry the box and liner to the center of the transition point of the shallow end, remove the vinyl liner from the box and place it on the floor of the pool with the red arrow facing the shallow end wall.

Unfold it toward the side walls. Grasp the bead and a few inches of the vinyl liner's shallow end wall and pull it toward the pool's shallow end/corners. Since the vinyl liner is fan folded, it will unfold easily. (*See Illustration 1*)

Gently adjust the vinyl liner's position as necessary. Use the factory installed arrows to locate and position corners, the breakover and/or ends of the center line. Do not kick it with abrasive footwear or toes with sharp nails.

### ***How to install the pool liner***

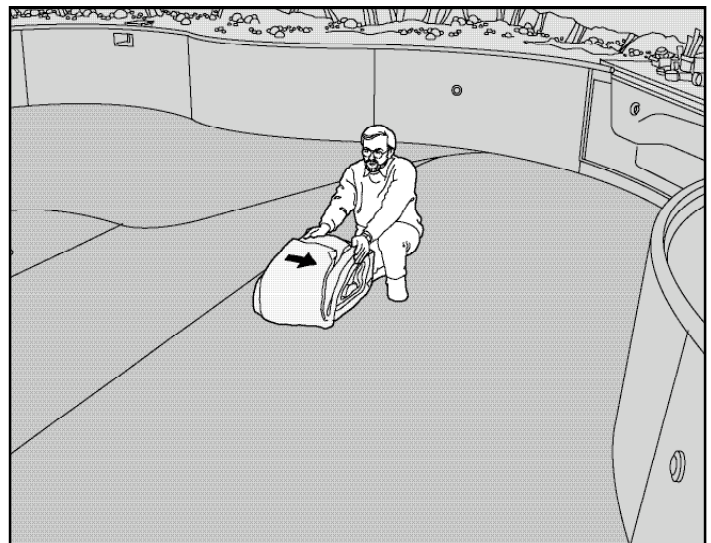

**1.** Position the folded liner at the breakover point with the red arrow pointing toward the shallow end wall.

## STEP 8 LINER INSTALLATION

### How to install the pool liner (continued)



**2.** Unfold the liner with the arrows pointing at the shallow end corners. Note plywood and 2x4 with strip to hold liner during install.

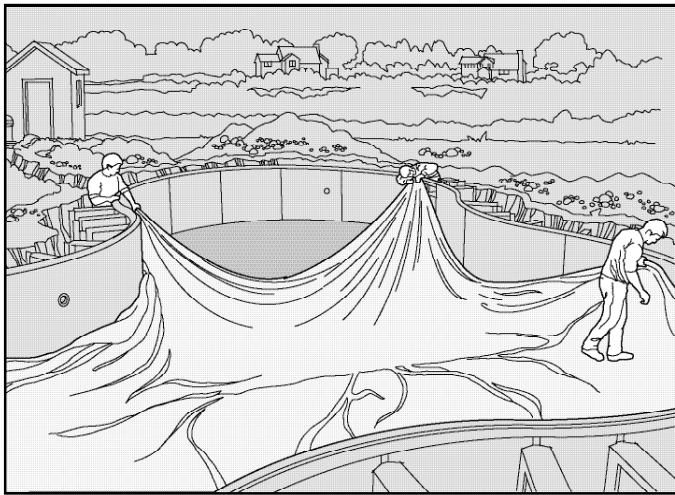

**3.** Unfold the rest of the liner toward the deep end of the pool.



**4.** Begin to insert the liner bead into the channel at the corners first and work toward the center.

### VINYL OVER STEP (VOS) INSTALLATIONS

Vinyl liners designed for vinyl over step (VOS) applications require locating and fitting of the step section(s) before any of the shallow end wall bead is put into place. The use of padded weights such as sand bags or water tubes is often necessary to hold VOS liners in position. If necessary, similar types of weights may also be used to hold the vinyl liner in place in other parts of the shallow end.

### VOS OR NON-VOS INSTALLATIONS

With the vinyl liner in proper position, insert the bead into the receiver track at the corners/end and at several points along the shallow end wall and shallow end side walls.

Next, find the corners/end of the opposite end of the vinyl liner. Remember to grasp the bead and several inches of the attached wall material with both hands. Doing so will prevent excessive stress on the bead to wall seam.

Unfold the vinyl liner as it is pulled toward the opposite end of the pool. DO NOT drag it against the coping, ladder sockets or any other potentially damaging surfaces. Properly position the vinyl liner while eliminating as many wrinkles as possible. Once all of the liner's corners/ends are aligned with the pool's corners/ends, insert the bead into the coping at each corner/end. After all the vinyl liner corners/ends are in place, proceed to the middle of the long and short walls and insert the bead into the coping. Continue to do so while working the material toward the corners/ends in both directions. This will prevent poor fitting and undesirable stress at all of the corners/ends.

(See Illustrations 2-4)

## STEP 8 LINER INSTALLATION

### FINAL POSITIONING OF THE VINYL LINER

An installer's primary goal at this point is to protect the properly positioned vinyl liner while eliminating all wrinkles. To accomplish this, there are several acceptable techniques for vacuuming a vinyl liner into place. The following are but two of those techniques:

#### ***Vacuumping a vinyl liner into place***

■ Remove about 6" of the bead from the receptor on one side wall near the break over. Insert the suction hose of a commercial vacuum between the vinyl liner and the wall to a depth of approximately 20" from the top of the pool. Create a seal around the hose to make the insertion point airtight. Use tape that will not damage the print on the liner and/or avoid putting any tape on the print. Seal all other openings into the pool, such as the skimmer cover, pipe ends and step cover, to prevent air leaks. (*See Illustration 5*)

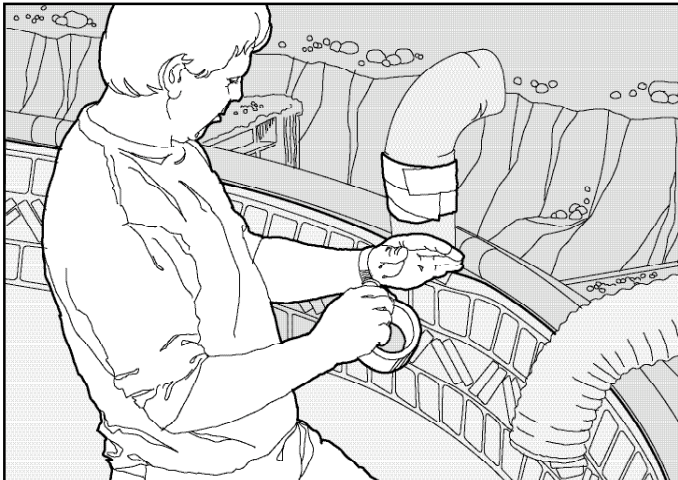

**5.** To vacuum a liner into place, insert a section of hose or plastic pipe between the liner and the wall. Use tape to create an air-tight seal.

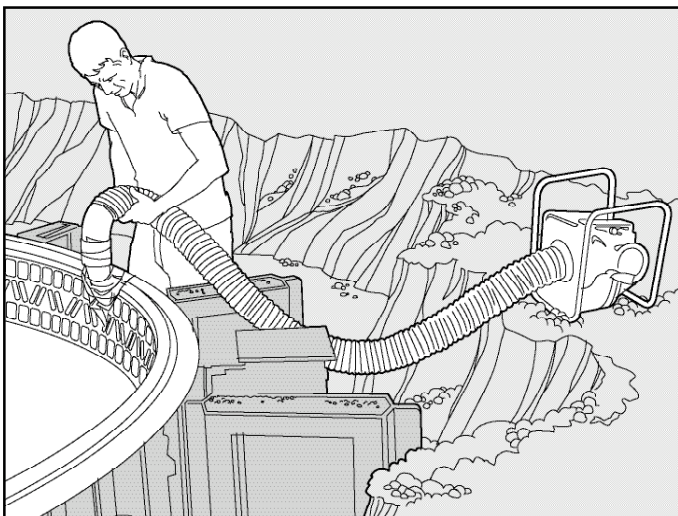

**6.** Turn the vacuum on and work out all wrinkles while adjusting the vinyl liner's position.

■ Insert a vacuum hose into the top of the skimmer and then through the face of it and down about 2' between the pool and vinyl liner. Seal the top of the skimmer and all other openings leading to the pool.

Turn the vacuum on and work out all wrinkles while adjusting the vinyl liner's position to match the pool configuration. Wrinkles can be removed by reaching over the wall and pulling on the vinyl liner sidewall material. Some installers enter the pool and use their stocking covered feet to kick it into place. This practice may result in damage to the vinyl liner causing the installer to become responsible for its replacement. Use caution at all time when handling a vinyl liner. (*See Illustration 6*)

### FITTING LINER TO NON-VOS STAIR/SEAT UNIT INSTALLATIONS

If a non-VOS unit is being used, the vinyl liner may be attached to it using a variety of techniques. Two of the commonly used methods are described below:

#### ***Dry Fit***

Once the entire liner bead is inserted into the track, return to the area of the face-plated unit with its faceplates and screws. Place a Dempsey cap over each end of the vertical faceplates. Hold the liner firmly down to the pool floor with one foot (no abrasive footwear) directly beneath one of the vertical faceplate locations. Do this to the point that the liner is stretched but not distorted. While placing the correct size faceplate into position, insert an awl tip into its uppermost hole. Proceed through the liner and on into the corresponding predrilled hole in the unit. Use a second awl to locate the next hole in the same fashion.

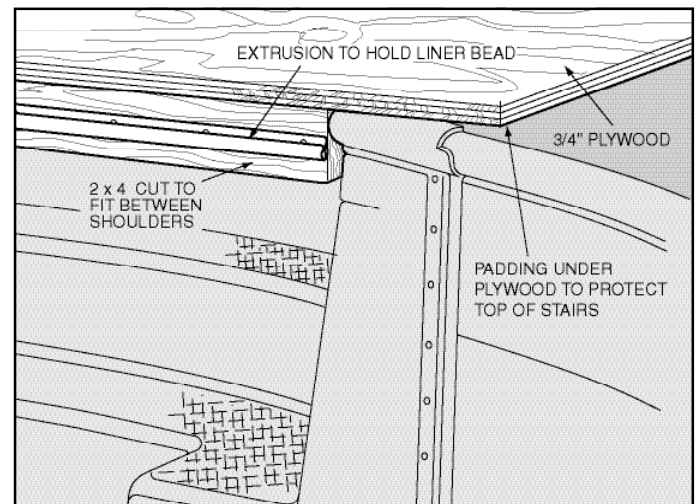

**7.** A sheet of plywood with a 2x4 is used to hold liner over unit. A length of receiver track is lined up with the pool wall track and screwed to the 2x4. This is helpful with the dry fit method and is essential with the wet fit method.

## STEP 8 LINER INSTALLATION

Remove the first awl and insert it into the third hole.  
*(See Illustration 6)*

Use a clutched drill to drive home a screw into the first hole. Do so without distorting the faceplate. Use the second awl to locate the fourth hole and proceed in the sequence described above. *(See Illustration 8-9)* Upon installation of the first vertical faceplate, install the opposite faceplate in the same manner. Slide the cover strip ends under the Dempsey caps and snap the remaining length into place. *(See Illustration 11)*

The horizontal faceplate should be installed by fastening one end first, then the opposite end. Find the center hole and insert a screw just deep enough into the unit to prevent the face plate from drooping. Using the awls again, work

from the second screw of one end continuing to the opposite end until all the screws are in place. It is recommended that all screws are tested with a manual driver to be certain that they are seated *(See Illustration 10)*. This must all take place while the liner is being held firmly to the pool floor. Once the faceplate is secure, snap on the cover strip starting at one end and work toward the other.

### Wet Fit

This technique requires that a separate, air-tight seal be established above all face-plated units except the 2' wall ladder. A sheet of 3/4" plywood, with a 2" x 4" screwed to the underside of one edge can be used as a cover over these products. The underside of the plywood should be padded with a material that will prevent damage to the

### How to install the pool liner (cont.)

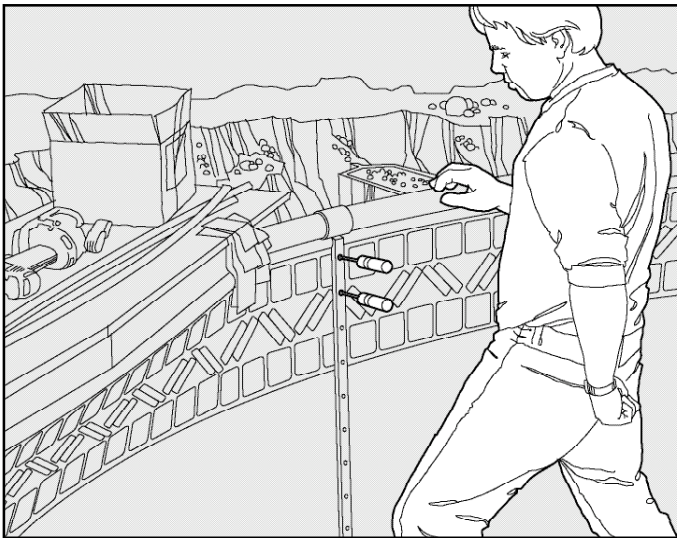

**8.** First, draw the liner tight with your foot, align faceplate and locate the first two screw holes in stair unit flange with the tip of an awl. Note the plywood and 2x4 with channel used to hold liner over unit. Also note the duck tape sealing the liner for vacuum wet fit method.

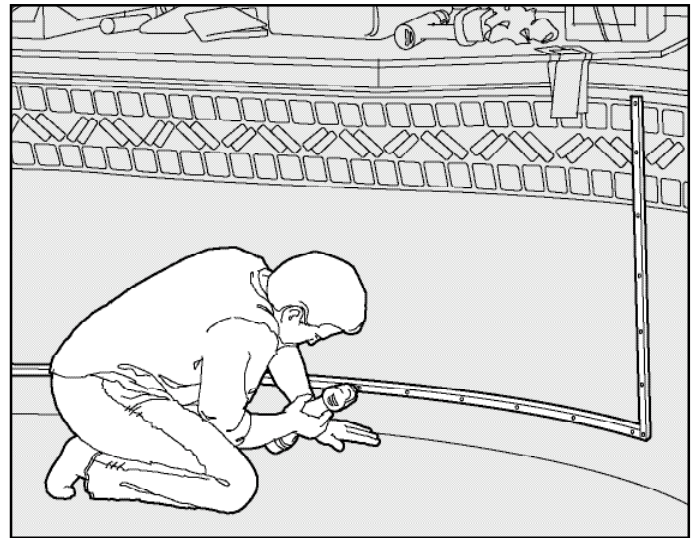

**10.** Install horizontal faceplate next. Using the above procedure, put one screw in each end first, one in the center and then work towards the center from the ends.

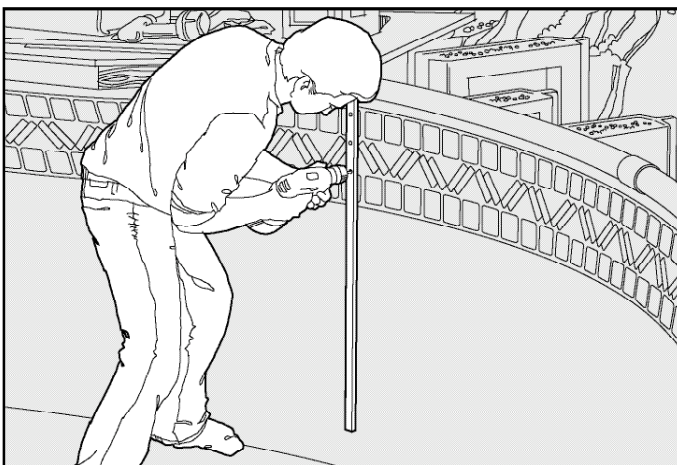

**9.** Move the awl to the third hole, drive a screw in the first hole, locate the next hole and repeat. Do the same with the opposite faceplate.

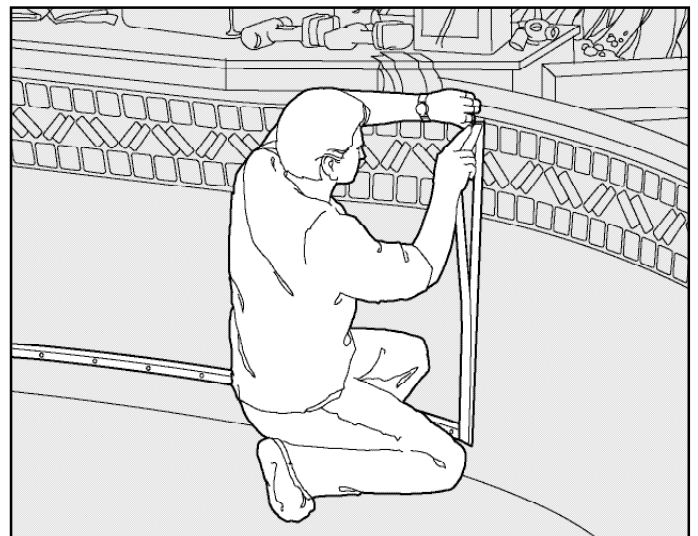

**11.** Snap cover strips into place.

## STEP 8 LINER INSTALLATION

product and create a temporary seal with the step. The 2" x 4" must be cut to fit the internal width of the unit. With the face of the 2" x 4" flush with the vertical plane of the adjacent walls, a length of receiver track can be fastened to the board at the same height of the track in the coping. (See *Illustration 7*) Insert the liner bead into that receiver track and apply tape over any openings to create an air-tight seal. Proceed with final positioning of the liner as described in the section below. Once the water level is just below the horizontal faceplate location, the faceplates can be installed in the manner and sequence detailed in the DRY FIT section. In each case, use a sharp utility knife to carefully cut the liner immediately inside the faceplates. (See *Illustration 12*) Give the material to the homeowner for potential patching purposes.

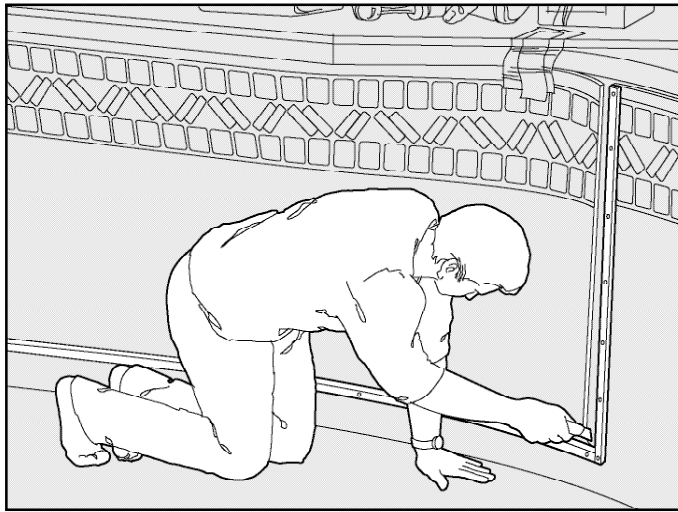

**12.** Trim liner just inside the face plate.

It is recommended that novice installers seek advice and training from experienced colleagues to become proficient in these techniques.

### **Install main drain covers**

Once the vinyl liner is positioned properly, fits well and all wrinkles have been removed, the main drain(s) cover(s) may be installed. The pool may then be filled with water while leaving the vacuum running. Once the water level is approximately one foot deep in the shallowest part of the pool, the vacuum may be shut off and the hose removed. If the hose was introduced at the receptor track, the tape should be removed and that portion of the vinyl liner bead should be inserted into the receptor track. The pool can then be filled to its operational level. Once that level is reached, the remaining gaskets and faceplates may be installed.

### **Safety rope**

The current NSPI/ANSI Standard requires the installation of a safety rope with floats across the width of the pool parallel to and no less than one foot and no more than two feet from the point of the first slope change in water depths less than four feet six inches.

Proper placement of NO DIVING labels should also occur at this time. See the safety packet enclosed with each Pacific vinyl liner and follow every instruction. Review all the information with the pool owner and leave it in their possession.

It is every installer's responsibility to be familiar with the current NSPI/ANSI standard.

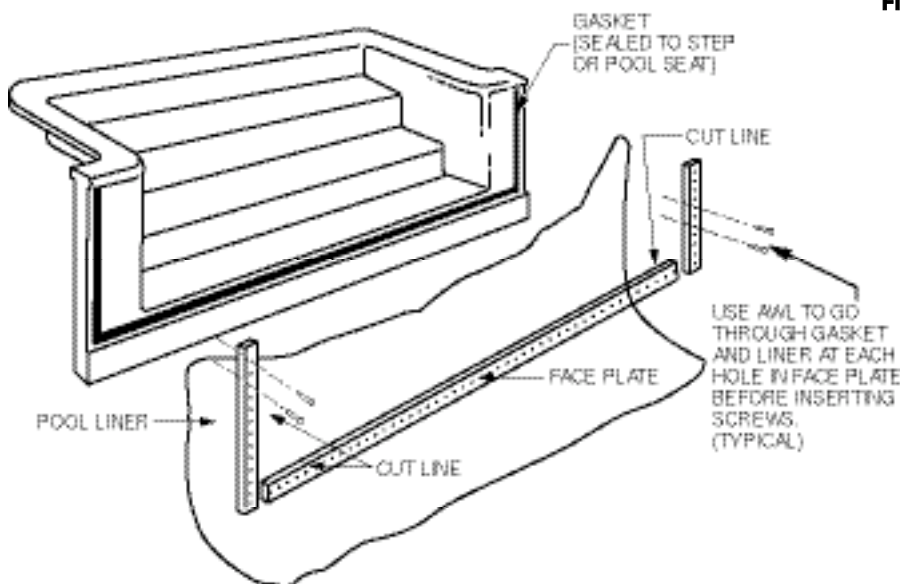

**FIGURE DD** – Typical faceplate step unit, gasket and trim

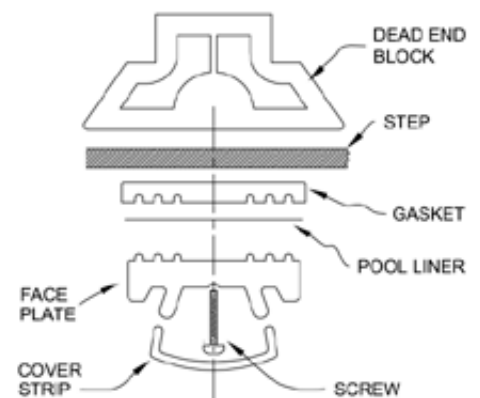

## STEP 8 LINER INSTALLATION

### **IF THE VINYL LINER DOES NOT FIT:**

In the unlikely event that the vinyl liner does not fit, **DO NOT FILL THE POOL WITH WATER** and **DO NOT CUT THE VINYL LINER OR ATTACH ANY FITTINGS!!**

First, determine that the vacuum is effective. Reassess the vinyl liner's position in the pool. Be sure the liner ends are not reversed; this is a common mistake made by installers of every experience level. Look at the floor of the vinyl liner, in most instances there are fewer seams in the shallow end. If repositioning is necessary, shut off the vacuum and move the vinyl liner accordingly.

Check for unusual features of the pool that may have been omitted from the order form such as a cove in the shallow end or a straight step cut on a corner step or a radius section of the wall.

Compare the corners of the pool with those of the vinyl liner to be sure they are the same arc, shape and/or length.

If the vinyl liner requires modification, make a sketch of the pool on a copy of the pool's design and indicate on it the location and type of alteration needed.

**DO NOT WRITE ON THE VINYL LINER WITH A MARKER OR PEN!**

**DO NOT APPLY DUCT TAPE TO ANY OF ITS PRINTED SURFACES!**

Contact the distributor from whom the vinyl liner was purchased. It is the distributor's responsibility to contact a Latham Plastics, Inc. Customer Service representative to arrange the rework or replacement of the vinyl liner. Keep it clean and dry. Dirt and moisture affect the integrity of vinyl, which in turn limits its potential for reuse. The product must be returned clean and dry in its original carton.

***Vinyl liners returned in poor condition cannot be reworked.*** (See technical attachments.)